

Top View LEDs

BLA-4014PZ1EN3C-C1Q6E3448D2832



Features

Lead (Pb) Free Product - RoHS Compliant

- RoHS compliant.
- PLCC-2 package.
- Wide viewing angle 120°.
- Inner reflector and white package.
- Qualification according to AEC-Q102.
- Precondition: Bases on JEDEC J-STD 020D Level 3.
- Automotive reflow profile (Reflow or wave soldering)
- The product itself will remain within RoHS compliant version.
- Compliance with EU REACH.
- Compliance Halogen Free (Br<900 ppm ,Cl <900 ppm, Br+Cl <1500 ppm).

Applications

- Automotive backlighting or indicator: Dashboard, switch, audio and video equipments...etc.
- Backlight: LCD, switches, symbol, mobile phone and illuminated advertising.
- Display for indoor and outdoor application.
- Ideal for coupling into light guides.
- Substitution of traditional light.
- Optical indicator.
- General applications

Device Selection Guide

Chip Materials	Emitted Color	Resin Color
InGaN	White	Yellowish

Absolute Maximum Ratings (Ta=25°C)

Parameter	Symbol	Rating	Unit
Forward Current	I _F	180	mA
Peak Forward Current (Duty 1/10 @100Hz)	I _{FP}	270	mA
Power Dissipation	P _d	594	mW
Junction Temperature	T _j	125	°C
Operating Temperature	T _{opr}	-40 ~ +100	°C
Storage Temperature	T _{stg}	-40 ~ +110	°C
Thermal Resistance	R _{th J-S}	22	K/W
Electrostatic Discharge(HBM)	ESD	5000`	V
Soldering Temperature	T _{sol}	Reflow Soldering : 260 °C for 30 sec. Hand Soldering : 350 °C for 3 sec.	

Electro-Optical Characteristics (Ta=25°C)

Parameter	Symbol	Min.	Typ.	Max.	Unit	Condition
Luminous Intensity	I _v	34		50	lm	
Viewing Angle	2θ _{1/2}	---	120	---	deg	I _F = 120mA
Forward Voltage	V _F	2.8		3.3	V	

Note:

1. Tolerance of Luminous Intensity: ±5%
2. Tolerance of Chromaticity Coordinates is ±0.005
3. Tolerance of Forward Voltage: ±0.05V

Bin Range of Luminous Intensity

Bin Code	Min.	Max.	Unit	Condition
E34	34	36	lm	$I_F = 120\text{mA}$
E36	36	38		
E38	38	40		
E40	40	42		
E42	42	44		
E44	44	46		
E46	46	48		
E48	48	50		

Note:
 Tolerance of Luminous Intensity: $\pm 5\%$

Bin Range of Forward Voltage

Bin Code	Min.	Max.	Unit	Condition
D28	2.8	2.9	V	$I_F = 120\text{mA}$
D29	2.9	3.0		
D30	3.0	3.1		
D31	3.1	3.2		
D32	3.2	3.3		

Note : Tolerance of Forward Voltage: $\pm 0.05\text{V}$

The C.I.E. 1931 Chromaticity Diagram

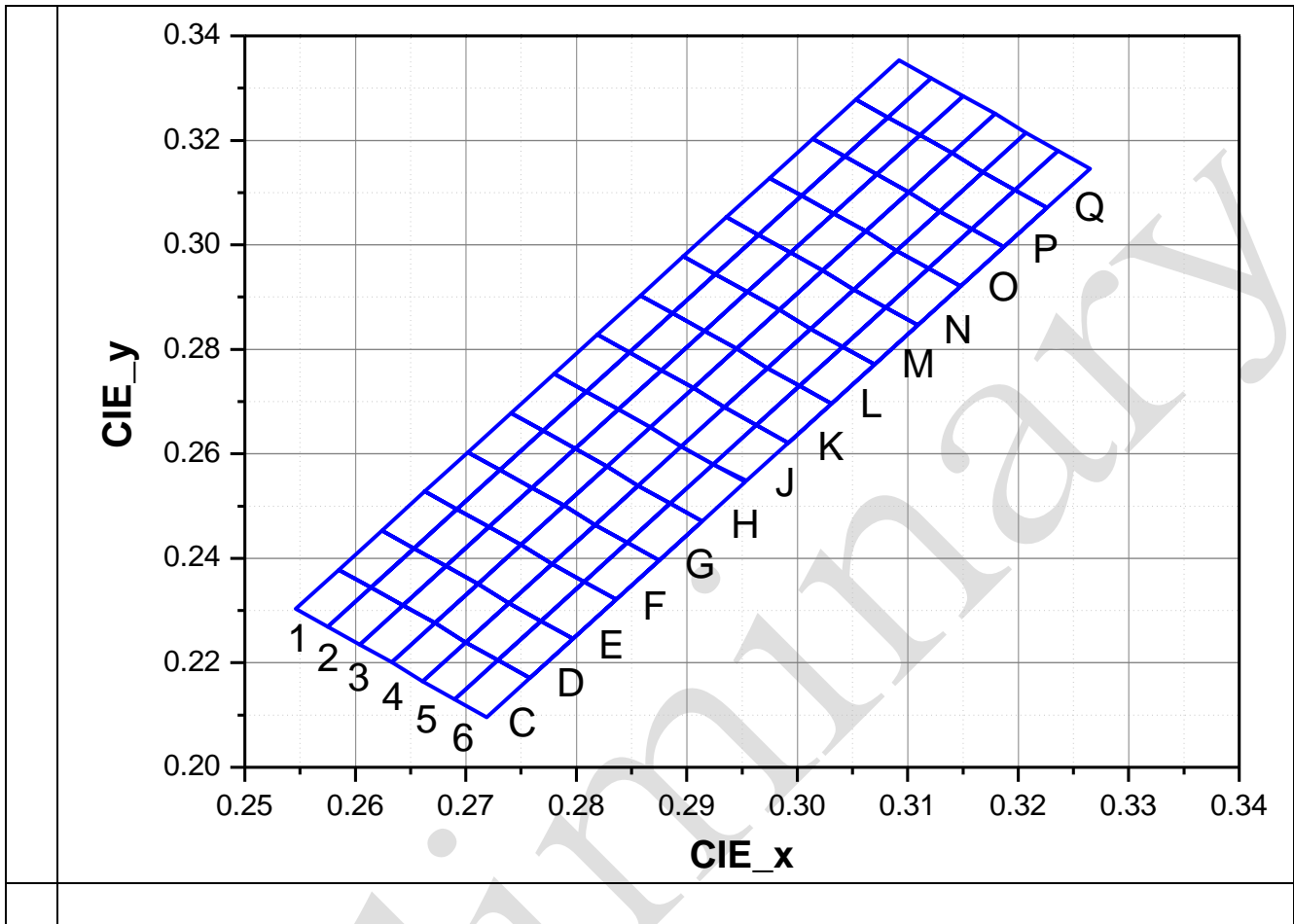

Bin Range of Chromaticity Coordinates Specifications

Bin Code	CIE_x	CIE_y	Bin Code	CIE_x	CIE_y
Q1	0.3082	0.3244	Q2	0.3111	0.3210
	0.3053	0.3278		0.3082	0.3244
	0.3092	0.3353		0.3121	0.3319
	0.3121	0.3319		0.3150	0.3285
P1	0.3043	0.3169	P2	0.3072	0.3135
	0.3014	0.3203		0.3043	0.3169
	0.3053	0.3278		0.3082	0.3244
	0.3082	0.3244		0.3111	0.3210
O1	0.3004	0.3094	O2	0.3033	0.3060
	0.2975	0.3128		0.3004	0.3094
	0.3014	0.3203		0.3043	0.3169
	0.3043	0.3169		0.3072	0.3135
N1	0.2965	0.3019	N2	0.2994	0.2985
	0.2936	0.3053		0.2965	0.3019
	0.2975	0.3128		0.3004	0.3094
	0.3004	0.3094		0.3033	0.3060
M1	0.2926	0.2944	M2	0.2955	0.2910
	0.2897	0.2978		0.2926	0.2944
	0.2936	0.3053		0.2965	0.3019
	0.2965	0.3019		0.2994	0.2985
L1	0.2887	0.2869	L2	0.2916	0.2835
	0.2858	0.2903		0.2887	0.2869
	0.2897	0.2978		0.2926	0.2944
	0.2926	0.2944		0.2955	0.2910
K1	0.2848	0.2794	K2	0.2877	0.2760
	0.2819	0.2828		0.2848	0.2794
	0.2858	0.2903		0.2887	0.2869
	0.2887	0.2869		0.2916	0.2835
J1	0.2809	0.2719	J2	0.2838	0.2685
	0.2780	0.2753		0.2809	0.2719
	0.2819	0.2828		0.2848	0.2794
	0.2848	0.2794		0.2877	0.2760

Bin Range of Chromaticity Coordinates Specifications

Bin Code	CIE_x	CIE_y	Bin Code	CIE_x	CIE_y
H1	0.2770	0.2644	H2	0.2799	0.2610
	0.2741	0.2678		0.2770	0.2644
	0.2780	0.2753		0.2809	0.2719
	0.2809	0.2719		0.2838	0.2685
G1	0.2731	0.2569	G2	0.2760	0.2535
	0.2702	0.2603		0.2731	0.2569
	0.2741	0.2678		0.2770	0.2644
	0.2770	0.2644		0.2799	0.2610
F1	0.2692	0.2494	F2	0.2721	0.2460
	0.2663	0.2528		0.2692	0.2494
	0.2702	0.2603		0.2731	0.2569
	0.2731	0.2569		0.2760	0.2535
E1	0.2653	0.2419	E2	0.2682	0.2385
	0.2624	0.2453		0.2653	0.2419
	0.2663	0.2528		0.2692	0.2494
	0.2692	0.2494		0.2721	0.2460
D1	0.2614	0.2344	D2	0.2643	0.2310
	0.2585	0.2378		0.2614	0.2344
	0.2624	0.2453		0.2653	0.2419
	0.2653	0.2419		0.2682	0.2385
C1	0.2575	0.2269	C2	0.2604	0.2235
	0.2546	0.2303		0.2575	0.2269
	0.2585	0.2378		0.2614	0.2344
	0.2614	0.2344		0.2643	0.2310

Bin Range of Chromaticity Coordinates Specifications

Bin Code	CIE_x	CIE_y	Bin Code	CIE_x	CIE_y
Q3	0.3140	0.3176	Q4	0.3168	0.3139
	0.3111	0.3210		0.3140	0.3176
	0.3150	0.3285		0.3179	0.3251
	0.3179	0.3251		0.3207	0.3214
P3	0.3101	0.3101	P4	0.3129	0.3064
	0.3072	0.3135		0.3101	0.3101
	0.3111	0.3210		0.3140	0.3176
	0.3140	0.3176		0.3168	0.3139
O3	0.3062	0.3026	O4	0.3090	0.2989
	0.3033	0.3060		0.3062	0.3026
	0.3072	0.3135		0.3101	0.3101
	0.3101	0.3101		0.3129	0.3064
N3	0.3023	0.2951	N4	0.3051	0.2914
	0.2994	0.2985		0.3023	0.2951
	0.3033	0.3060		0.3062	0.3026
	0.3062	0.3026		0.3090	0.2989
M3	0.2984	0.2876	M4	0.3012	0.2839
	0.2955	0.2910		0.2984	0.2876
	0.2994	0.2985		0.3023	0.2951
	0.3023	0.2951		0.3051	0.2914
L3	0.2945	0.2801	L4	0.2973	0.2764
	0.2916	0.2835		0.2945	0.2801
	0.2955	0.2910		0.2984	0.2876
	0.2984	0.2876		0.3012	0.2839
K3	0.2906	0.2726	K4	0.2934	0.2689
	0.2877	0.2760		0.2906	0.2726
	0.2916	0.2835		0.2945	0.2801
	0.2945	0.2801		0.2973	0.2764
J3	0.2867	0.2651	J4	0.2895	0.2614
	0.2838	0.2685		0.2867	0.2651
	0.2877	0.2760		0.2906	0.2726
	0.2906	0.2726		0.2934	0.2689

Bin Range of Chromaticity Coordinates Specifications

Bin Code	CIE_x	CIE_y	Bin Code	CIE_x	CIE_y
H3	0.2828	0.2576	H4	0.2856	0.2539
	0.2799	0.2610		0.2828	0.2576
	0.2838	0.2685		0.2867	0.2651
	0.2867	0.2651		0.2895	0.2614
G3	0.2789	0.2501	G4	0.2817	0.2464
	0.2760	0.2535		0.2789	0.2501
	0.2799	0.2610		0.2828	0.2576
	0.2828	0.2576		0.2856	0.2539
F3	0.2750	0.2426	F4	0.2778	0.2389
	0.2721	0.2460		0.2750	0.2426
	0.2760	0.2535		0.2789	0.2501
	0.2789	0.2501		0.2817	0.2464
E3	0.2711	0.2351	E4	0.2739	0.2314
	0.2682	0.2385		0.2711	0.2351
	0.2721	0.2460		0.2750	0.2426
	0.2750	0.2426		0.2778	0.2389
D3	0.2672	0.2276	D4	0.2700	0.2239
	0.2643	0.2310		0.2672	0.2276
	0.2682	0.2385		0.2711	0.2351
	0.2711	0.2351		0.2739	0.2314
C3	0.2633	0.2201	C4	0.2661	0.2164
	0.2604	0.2235		0.2633	0.2201
	0.2643	0.2310		0.2672	0.2276
	0.2672	0.2276		0.2700	0.2239

Bin Range of Chromaticity Coordinates Specifications

Bin Code	CIE_x	CIE_y	Bin Code	CIE_x	CIE_y
Q5	0.3197	0.3105	Q6	0.3226	0.3071
	0.3168	0.3139		0.3197	0.3105
	0.3207	0.3214		0.3236	0.3180
	0.3236	0.3180		0.3265	0.3146
P5	0.3158	0.3030	P6	0.3187	0.2996
	0.3129	0.3064		0.3158	0.3030
	0.3168	0.3139		0.3197	0.3105
	0.3197	0.3105		0.3226	0.3071
O5	0.3119	0.2955	O6	0.3148	0.2921
	0.3090	0.2989		0.3119	0.2955
	0.3129	0.3064		0.3158	0.3030
	0.3158	0.3030		0.3187	0.2996
N5	0.3080	0.2880	N6	0.3109	0.2846
	0.3051	0.2914		0.3080	0.2880
	0.3090	0.2989		0.3119	0.2955
	0.3119	0.2955		0.3148	0.2921
M5	0.3041	0.2805	M6	0.3070	0.2771
	0.3012	0.2839		0.3041	0.2805
	0.3051	0.2914		0.3080	0.2880
	0.3080	0.2880		0.3109	0.2846
L5	0.3002	0.2730	L6	0.3031	0.2696
	0.2973	0.2764		0.3002	0.2730
	0.3012	0.2839		0.3041	0.2805
	0.3041	0.2805		0.3070	0.2771
K5	0.2963	0.2655	K6	0.2992	0.2621
	0.2934	0.2689		0.2963	0.2655
	0.2973	0.2764		0.3002	0.2730
	0.3002	0.2730		0.3031	0.2696
J5	0.2924	0.2580	J6	0.2954	0.2549
	0.2895	0.2614		0.2924	0.2580
	0.2934	0.2689		0.2963	0.2655
	0.2963	0.2655		0.2992	0.2621

Bin Range of Chromaticity Coordinates Specifications

Bin Code	CIE_x	CIE_y	Bin Code	CIE_x	CIE_y
H5	0.2885	0.2505	H6	0.2914	0.2471
	0.2856	0.2539		0.2885	0.2505
	0.2895	0.2614		0.2924	0.2580
	0.2924	0.2580		0.2953	0.2546
G5	0.2846	0.2430	G6	0.2875	0.2396
	0.2817	0.2464		0.2846	0.2430
	0.2856	0.2539		0.2885	0.2505
	0.2885	0.2505		0.2914	0.2471
F5	0.2807	0.2355	F6	0.2836	0.2321
	0.2778	0.2389		0.2807	0.2355
	0.2817	0.2464		0.2846	0.2430
	0.2846	0.2430		0.2875	0.2396
E5	0.2768	0.2280	E6	0.2797	0.2246
	0.2739	0.2314		0.2768	0.2280
	0.2778	0.2389		0.2807	0.2355
	0.2807	0.2355		0.2836	0.2321
D5	0.2729	0.2205	D6	0.2758	0.2171
	0.2700	0.2239		0.2729	0.2205
	0.2739	0.2314		0.2768	0.2280
	0.2768	0.2280		0.2797	0.2246
C5	0.2690	0.2130	C6	0.2719	0.2096
	0.2661	0.2164		0.2690	0.2130
	0.2700	0.2239		0.2729	0.2205
	0.2729	0.2205		0.2758	0.2171

Notes: Tolerance of Chromaticity Coordinates: ± 0.005

Package Dimension

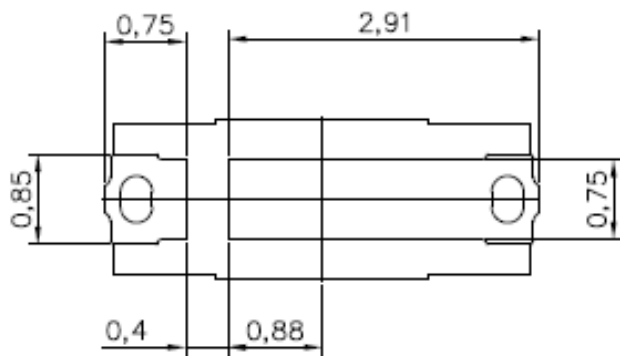
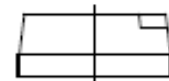
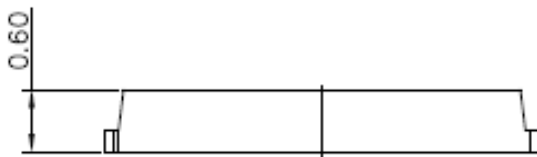
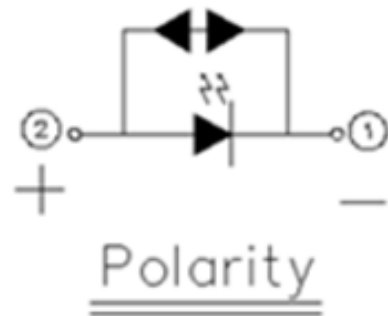
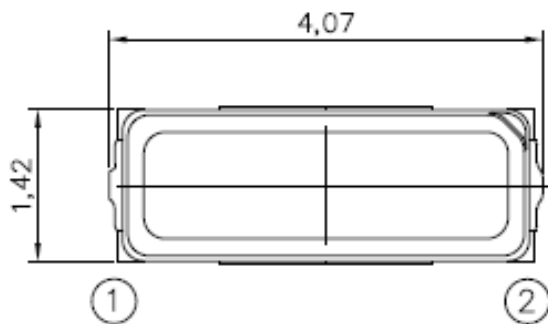

Bot. view

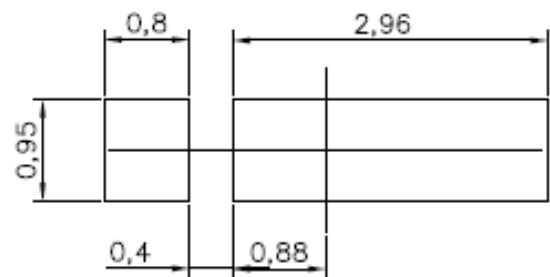

Soldering patterns

Note: Tolerances unless mentioned ± 0.1 mm. Unit = mm

Typical Electro-Optical-Thermal Characteristics Curves

1. Spectrum Distribution

($T_a=25^{\circ}\text{C}$, $I_f=120\text{mA}$)

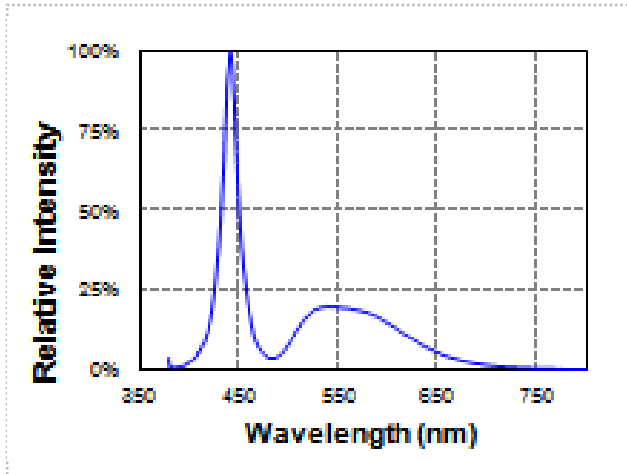

2. Relative Luminous Flux vs. Forward Current

($T_a=25^{\circ}\text{C}$)

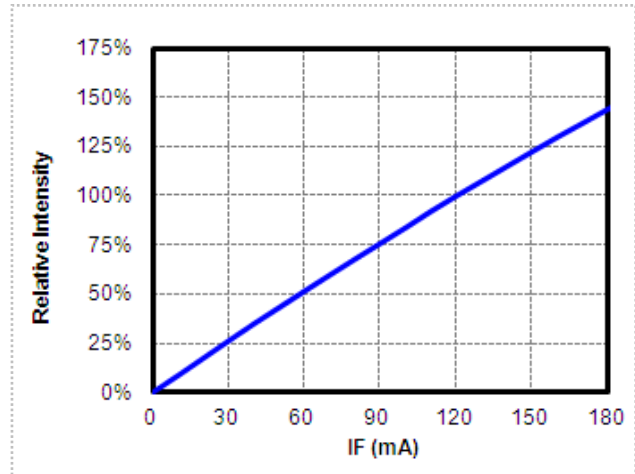

3. Relative Forward Voltage vs. Forward Current

($T_a=25^{\circ}\text{C}$)

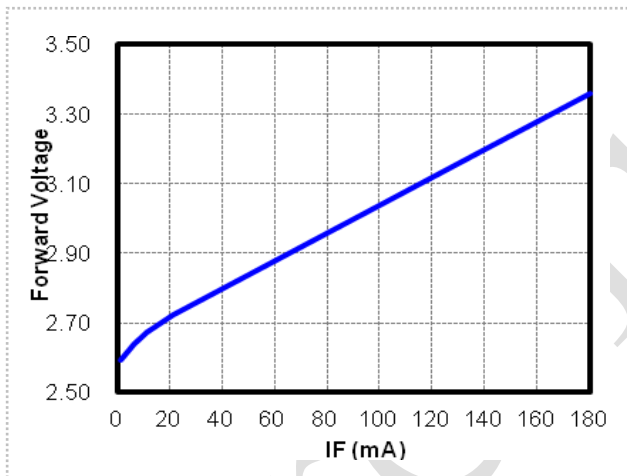

4. Radiation Diagram

($T_a=25^{\circ}\text{C}$, $I_f=120\text{mA}$)

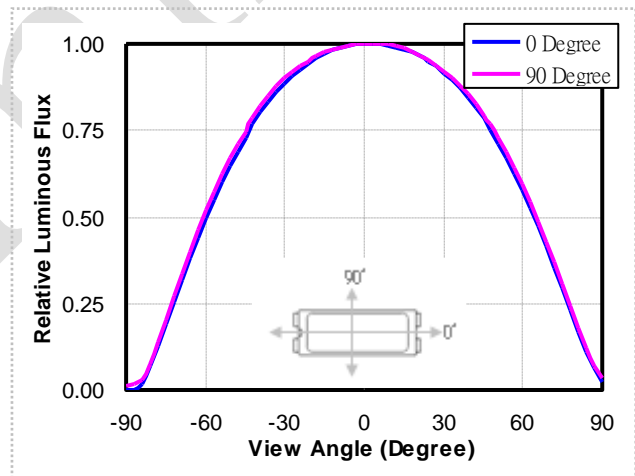

Typical Electro-Optical-Thermal Characteristics Curves

5. Relative Luminous Flux vs. Ambient Temperature
 ($I_F=120\text{mA}$)

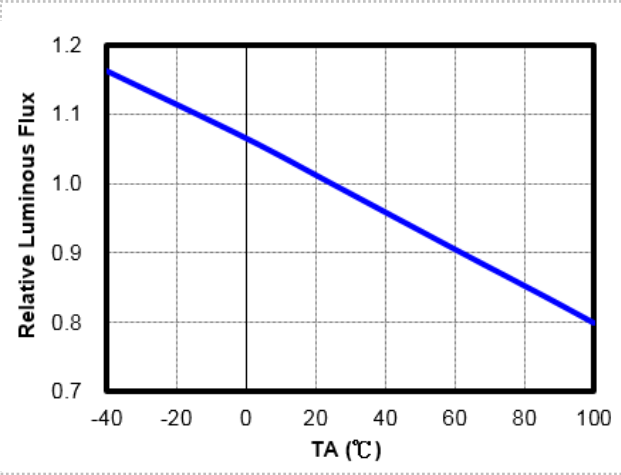

6. Forward Voltage vs. Ambient Temperature
 ($I_F=120\text{mA}$)

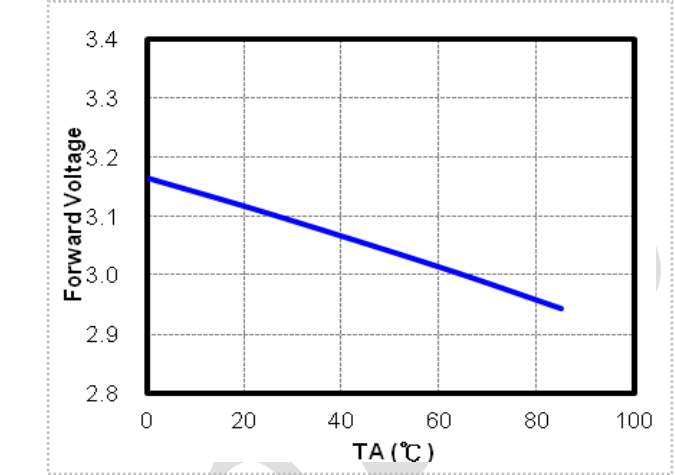

7. Chromaticity Coordinates vs. Ambient Temperature
 ($I_F=120\text{mA}$)

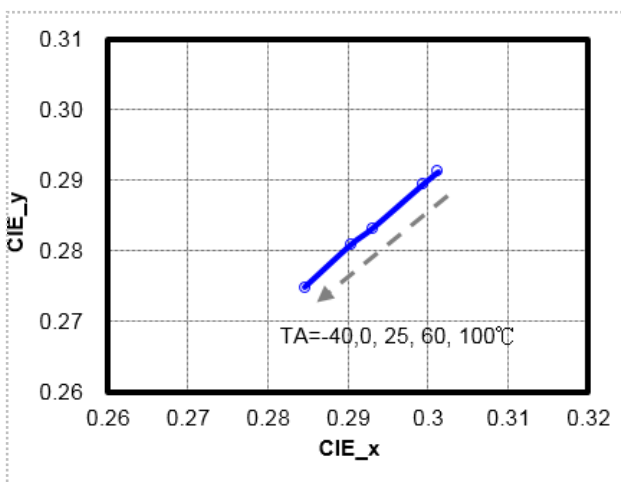

8. Forward Current De-rating Curve

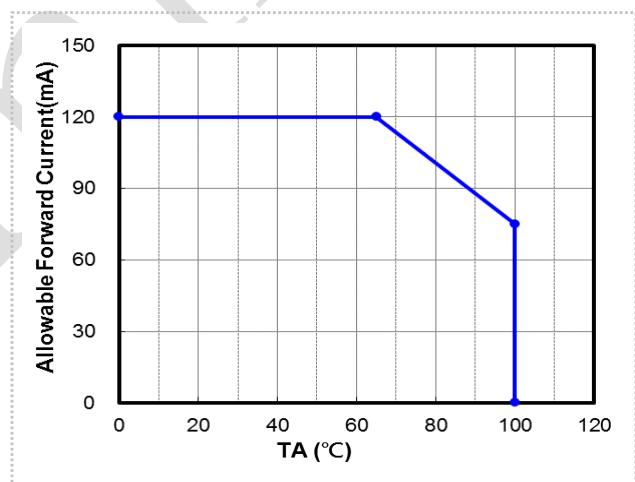

**Moisture Resistant Packing Materials
 Label Explanation**

- CPN: Customer's Product Number
- P/N: Product Number
- QTY: Packing Quantity
- CAT: Luminous Intensity Rank
- HUE: Chromaticity Coordinates Rank
- REF: Forward Voltage Rank
- LOT No: Lot Number

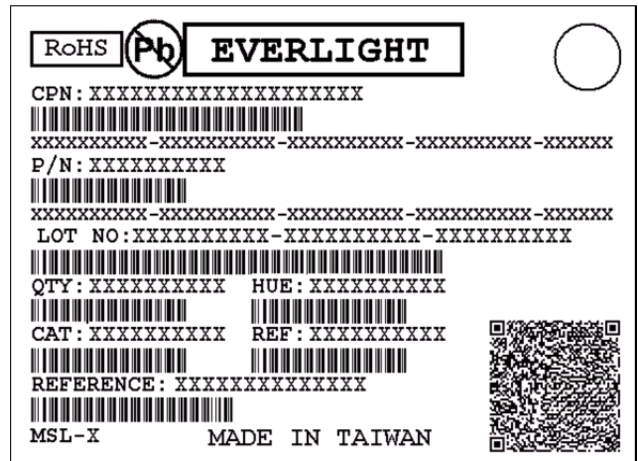

Reel Dimensions

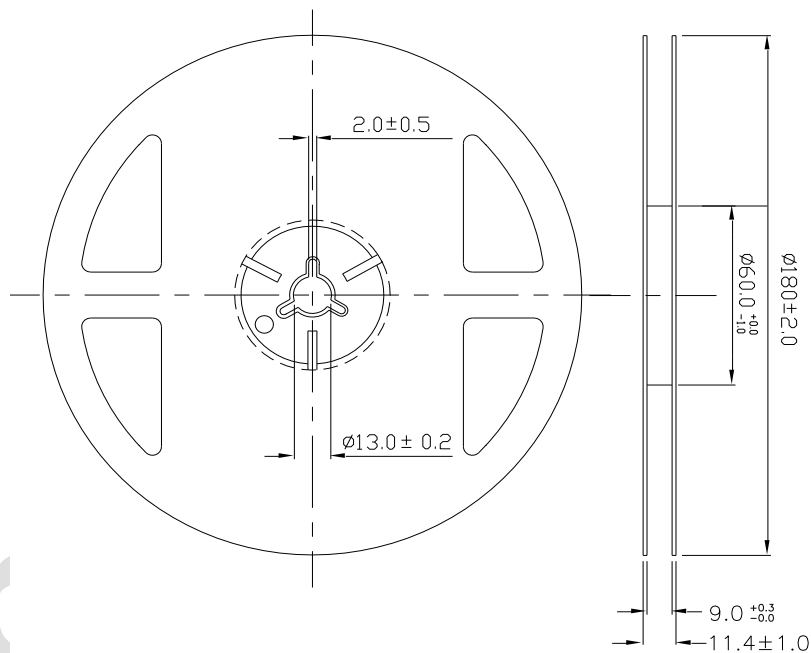

Note: Tolerances unless mentioned ± 0.1 mm. Unit = mm

Carrier Tape Dimensions: Loaded Quantity 500/1000/1500/2000 pcs Per Reel

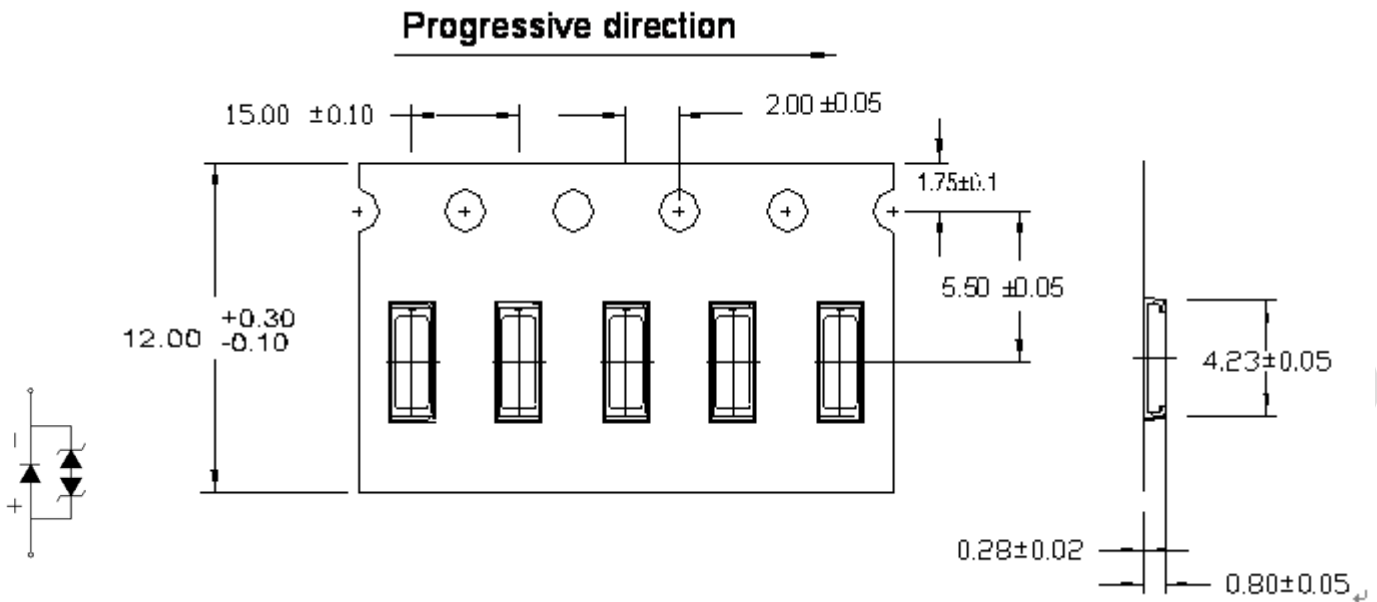

Note:
 1. Tolerances unless mentioned ± 0.1 mm. Unit = mm

Moisture Resistant Packing Process

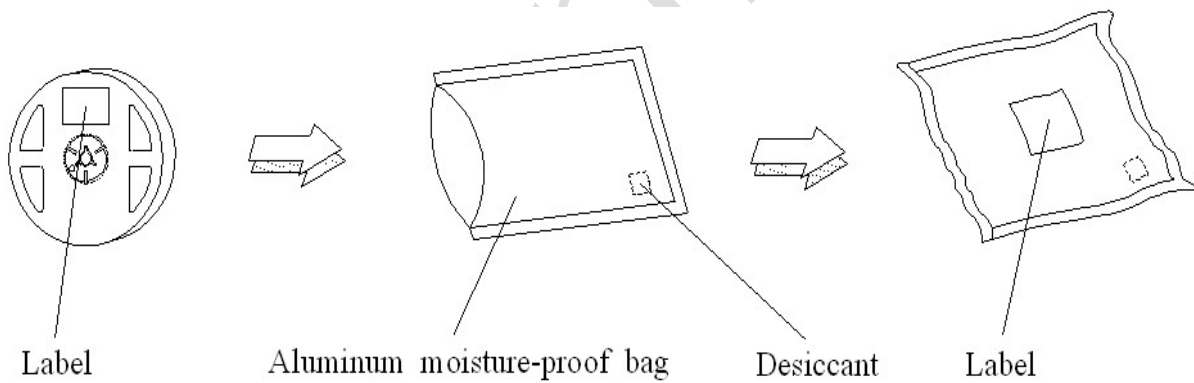

Note: Tolerances unless mentioned ± 0.1 mm. Unit = mm

Reliability Test Items and Conditions

The reliability of products shall be satisfied with items listed below.

Confidence level : 90%

LTPD : 10%

No.	Items	Test Condition		Test Hours/Cycles	Criteria (at std. IF)
		Temp./ Humidity	IF (mA)		
1	Reflow Soldering	Temp. : 260°C±5°C/30sec.	N/A	3 times	$\Delta I_v < \pm 10\%$ $\Delta VF < \pm 10\%$
2	Temperature Cycle	-40°C ~ 85°C 15min. (15min.) 15min.	N/A	1000 cycles	I _v > 70%, VF ± 10%,
3	Steady State Operating Life of High Temperature	TA=100°C	75	1000 hrs	
4	Steady State Operating Life of High Humidity Heat	TA=85°C/ 85%RH ON 30min / OFF 30min	120	1000 hrs	
5	H2S	40°C90% , 10~15 ppm H2S	N/A	336 hrs	
6	Flowing Mixed Gas	TA=25°C/75%RH H2S concentration 10x10 ⁻⁹ , SO2 concentration 200x10 ⁻⁹ , NO2 concentration 200x10 ⁻⁹ , Cl2 concentration 10x10 ⁻⁹	N/A	500 hrs	
7	DEW	30°C ~ 65°C 4hrs. (3hrs.) 4hrs 90%RH	120	1008hrs	
8	Pulse Temperature Cycle (PTC)	-40°C ~ 85°C 10min. (20min.) 10min. 5min ON/OFF	120	1000 cycles	

Precautions for Use

1. Soldering Condition (Reference: IPC/JEDEC J-STD-020D)

(A) Reflow

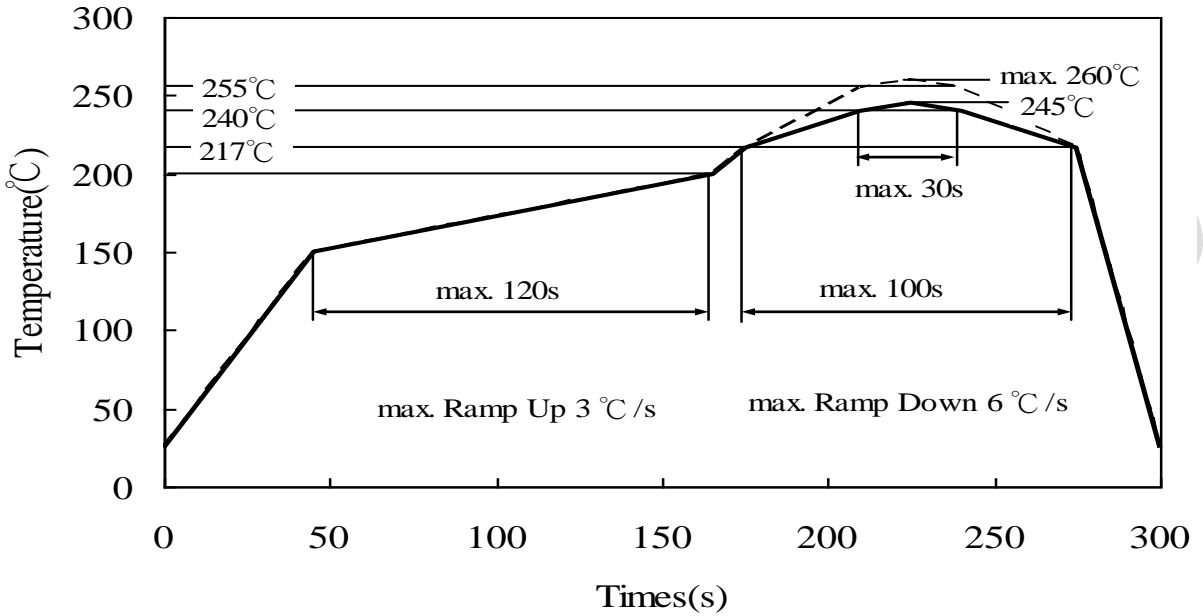

(B) Recommend soldering pad

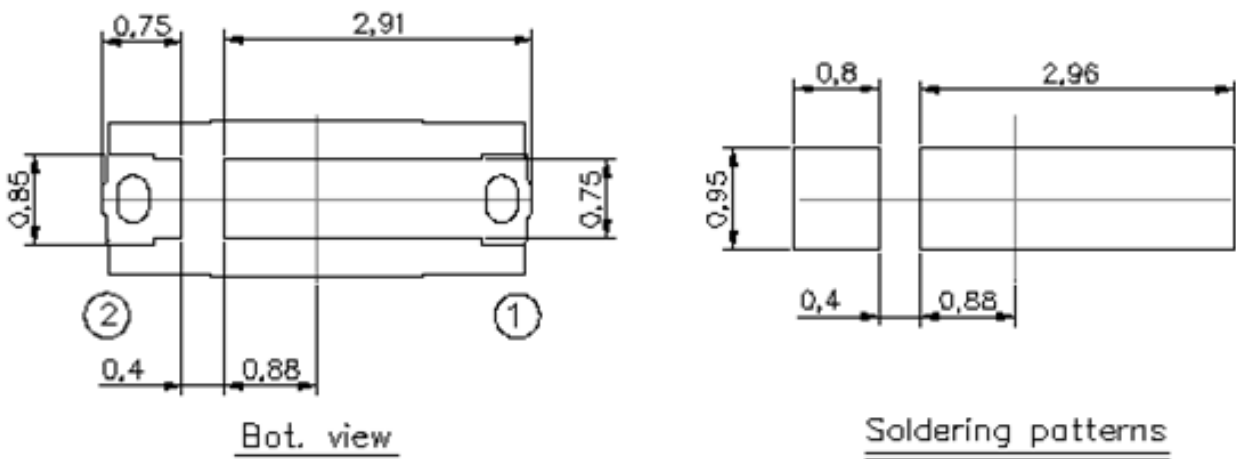

Note: Tolerances unless mentioned ± 0.1 mm. Unit = mm

2. Current limiting

A resistor should be used to limit current spikes that can be caused by voltage fluctuations. Otherwise damage could occur.

3. Storage

3.1 Moisture proof bag should only be opened immediately prior to usage.

3.2 Environment should be less than 30°C and 60% RH when moisture proof bag is opened.

3.3 After opening the package MSL Conditions stated on page 1 of this spec should not be exceeded.

3.4 If the moisture sensitivity card indicates higher than acceptable moisture, the component should be baked at min. 60deg +/-5deg for 24 hours.

4. Iron Soldering

Hand soldering is not recommended for regular production. These guidelines are for rework only. Soldering iron tip should contact each terminal no more than 3 sec at 350°C, using soldering iron with nominal power less than 25W. Allow min. 2 sec. between soldering intervals.

5. Usage

Do not exceed the values given in this specification.

Application Restrictions

High reliability applications such as military/aerospace, automotive safety/security systems, and medical equipment may require different product. If you have any concerns, please contact Everlight before using this product in your application. This specification guarantees the quality and performance of the product as an individual component. Do not use this product beyond the specification described in this document.