

For the electronic measurement of current: DC, AC, pulsed..., with galvanic separation between the primary and the secondary circuit.



Features

- Closed loop multi-range current transducer
- Voltage output
- Unipolar supply voltage.

Advantages

- Very low offset drift
- Very good dv/dt immunity.

Applications

- AC variable speed and servo motor drives
- Battery supplied applications
- Uninterruptible Power Supplies (UPS)
- Switched Mode Power Supplies (SMPS)
- Power supplies for welding applications
- Solar inverters.

Standards

- IEC 61800-3: 2017
- IEC 61800-5-1: 2007
- IEC 62109-1: 2010
- IEC 62477-1: 2012
- UL 508: 2018.

Application Domain

- Industrial.

Safety



Caution

If the device is used in a way that is not specified by the manufacturer, the protection provided by the device may be compromised. Always inspect the electronics unit and connecting cable before using this product and do not use it if damaged. Mounting assembly shall guarantee the maximum primary busbar temperature, fulfill clearance and creepage distance, minimize electric and magnetic coupling, and unless otherwise specified can be mounted in any orientation



Caution, risk of electrical shock

This transducer must be used in limited-energy secondary circuits SELV according to IEC 61800-5-1, in electric/electronic equipment with respect to applicable standards and safety requirements in accordance with the manufacturer's operating specifications.

When operating the transducer, certain parts of the module can carry hazardous voltage (e.g. primary busbar, power supply). All installations, maintenance, servicing operations and use must be carried out by trained and qualified personnel practicing applicable safety precautions.

If the transducer is used in a manner not specified by the manufacturer, the protection provided by the equipment may be impaired.

Ignoring this warning can lead to injury and/or cause serious damage.

This transducer is a build-in device, whose hazardous live parts must be inaccessible after installation.

This transducer must be mounted in a suitable end-enclosure.

Use caution during installation and use of this product; high voltages and currents may be present in circuit under test.

This transducer is a built-in device, not intended to be cleaned with any product. Nevertheless if the user must implement cleaning or washing process, validation of the cleaning program has to be done by himself.



ESD susceptibility

The product is susceptible to be damaged from an ESD event and the personnel should be grounded when handling it.

Do not dispose of this product as unsorted municipal waste. Contact a qualified recycler for disposal.



Underwriters Laboratory Inc. recognized component

Absolute maximum ratings

Parameter	Symbol	Unit	Value
Maximum supply voltage	$U_{C \max}$	V	7
Maximum primary current	$I_{P \max}$	A	$10 \times I_{P N}$
Maximum primary conductor temperature	$T_{B \max}$	°C	110
Electrostatic discharge voltage (HBM - Human Body Model)	$U_{ESD \text{ HBM}}$	kV	4

Stresses above these ratings may cause permanent damage.
Exposure to absolute maximum ratings for extended periods may degrade reliability.

UL 508: Ratings and assumptions of certification

File # E189713 Volume: 2 Section: 14.

Standards

- CSA C22.2 NO. 14-18 INDUSTRIAL CONTROL EQUIPMENT - Edition 13
- UL 508 STANDARD FOR INDUSTRIAL CONTROL EQUIPMENT - Edition 18

Ratings

Parameter	Symbol	Unit	Value
Primary involved potential		V AC/DC	1000
Max surrounding air temperature	T_A	°C	85
Primary current	I_P	A	Primary nominal current
Transducer supply	U_C	V DC	5
Output voltage	U_{out}	V	0 to 5

Conditions of acceptability

When installed in the end-use equipment, consideration shall be given to the following:

- 1 - These devices must be mounted in a suitable end-use enclosure.
- 2 - The terminals have not been evaluated for field wiring.
- 3 - The LZSR Series shall be used in a pollution degree 2 environment or better.
- 4 - Low voltage circuits are intended to be powered by a circuit derived from an isolating source (such as a transformer, optical isolator, limiting impedance or electro-mechanical relay) and having no direct connection back to the primary circuit (other than through the grounding means).
- 5 - These devices are intended to be mounted on the printed wiring board of the end-use equipment (with a minimum CTI of 100).
- 6 - LZSR Series: based on results of temperature tests, in the end-use application, a maximum of 110°C cannot be exceeded on the primary conductor.

Marking

Only those products bearing the UL or UR Mark should be considered to be Listed or Recognized and covered under UL's Follow-Up Service. Always look for the Mark on the product.

Insulation coordination

Parameter	Symbol	Unit	Value	Comment
RMS voltage for AC insulation test, 50 Hz, 1 min	U_d	kV	3	
Impulse withstand voltage 1.2/50 μ s	U_{Ni}	kV	8	
Partial discharge RMS test voltage ($q_m < 10$ pC)	U_t	kV	1650	
Insulation resistance	R_{INS}	G Ω	> 200	measured at 500 V DC
Clearance (pri. - sec.)	d_{Cl}	mm	12.9	Shortest distance through air
Creepage distance (pri. - sec.)	d_{Cp}	mm	12.9	Shortest path along device body
Case material	-	-	V0	According to UL 94
Comparative tracking index	CTI		600	
Application example System voltage RMS		V	600	Reinforced insulation according to IEC 61800-5-1, IEC 62109-1 CAT III, PD2
Application example System voltage RMS		V	1000	Basic insulation according to IEC 61800-5-1, IEC 62109-1 CAT III, PD2

Environmental and mechanical characteristics

Parameter	Symbol	Unit	Min	Typ	Max	Comment
Ambient operating temperature	T_A	$^{\circ}$ C	-40		85	
Ambient storage temperature	T_S	$^{\circ}$ C	-55		125	
Mass	m	g		44		

Electrical data

At $T_A = 25\text{ °C}$, $U_C = +5\text{ V}$, $N_p = 1$ turn, $R_L = 10\text{ k}\Omega$ internal reference unless otherwise noted (see Min, Max, typ. definition paragraph in page 8). Lines with a * in the comment column apply over the $-40 \dots 85\text{ °C}$ ambient temperature range.

Parameter	Symbol	Unit	Min	Typ	Max	Comment
Primary nominal RMS current	I_{PN}	A		80		*
Primary current, measuring range	I_{PM}	A		270		*
Supply voltage	U_C	V	4.75	5	5.25	*
Current consumption	I_C	mA		$18 + \frac{I_p(\text{mA})}{N_s}$	$20 + \frac{I_p(\text{mA})}{N_s}$	$N_s = 2026$ turns
Reference voltage @ $I_p = 0\text{ A}$	U_{ref}	V	2.485	2.5	2.515	Internal reference
Output voltage	U_{out}	V	0.25		4.75	with $U_C = +5\text{ V}$
Output voltage @ $I_p = 0\text{ A}$	U_{out}	V		U_{ref}		
Electrical offset voltage	U_{OE}	mV	-2.8		2.8	100 % tested $U_{out} - U_{ref}$
Electrical offset current referred to primary	I_{OE}	mA	-358		358	100 % tested
Temperature coefficient of I_{OE} referred to primary	TCI_{OE}	A/K	-0.002		0.002	
Temperature coefficient of U_{ref}	TCU_{ref}	ppm/K	-100		100	* Internal reference
Temperature coefficient of U_{out} @ $I_p = 0\text{ A}$	TCU_{out}	ppm/K	-3		3	* ppm/K of 2.5 V
Nominal sensitivity	S_N	mV/A		7.813		* 100 % tested
Sensitivity error	ϵ_s	%	-0.8		0.8	$625\text{ mV}/I_{PN}$
Temperature coefficient of S	TCS	ppm/K			75	* ppm/k of I_{PN}
Linearity error	ϵ_L	% of I_{PN}	-0.1		0.1	
Magnetic offset current ($10 \times I_{PN}$) referred to primary	I_{OM}	mA	-83		83	
RMS noise voltage spectral density 100 Hz ... 100 kHz referred to primary	u_{no}	$\mu\text{V}/\text{Hz}^{1/2}$		0.95		
Peak-to-peak noise voltage DC ... 10 kHz DC ... 100 kHz DC ... 1 MHz	$U_{no\text{pp}}$	mVpp		0.3 0.5 1.5		
Primary current, detection threshold	I_{PTh}	A	$2.35 \times I_{PN}$	$2.41 \times I_{PN}$	$2.47 \times I_{PN}$	
Delay time of threshold output for high value	t_{DHTH}	μs		1.4	2.2	* Overcurrent detection measured over temperature
Delay time to 10 % of I_{PN}	t_{D10}	μs			1	di/dt = 50 A/ μs
Delay time to 80 % of I_{PN}	t_{D80}	μs			3	
Frequency bandwidth ($\pm 3\text{ dB}$)	BW	kHz	200			
Total error	ϵ_{tot}	% of I_{PN}			1	See formula note ¹⁾
Total error @ $T_A = 85\text{ °C}$	ϵ_{tot}	% of I_{PN}			1.4	See formula note ¹⁾
Sum of sensitivity and linearity ¹⁾	ϵ_{SL}	% of I_{PN}			0.83	See formula note ²⁾
Sum of sensitivity and linearity @ $T_A = 85\text{ °C}$	ϵ_{SL}	% of I_{PN}			1.2	See formula note ²⁾

Notes: ¹⁾ $\epsilon_{tot}(T_A) = \epsilon_{tot25} + \left(TCS + \frac{TCI_{OE}}{I_{PN}} \right) \times |T_A - 25|$

²⁾ $\epsilon_{SL}(T_A) = \epsilon_{SL25} + \left(TCS + \frac{TCI_{OE}}{I_{PN}} \right) \times |T_A - 25|$

Typical performance characteristics

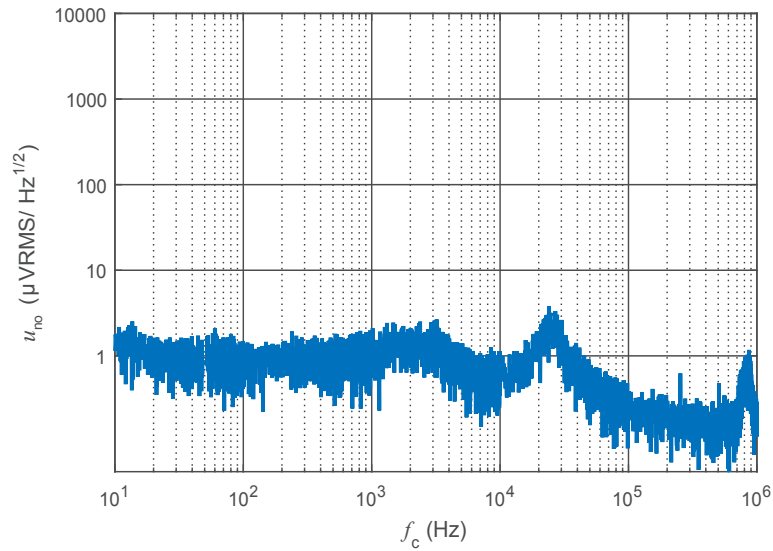

Figure 1: Noise voltage spectral density referred to primary

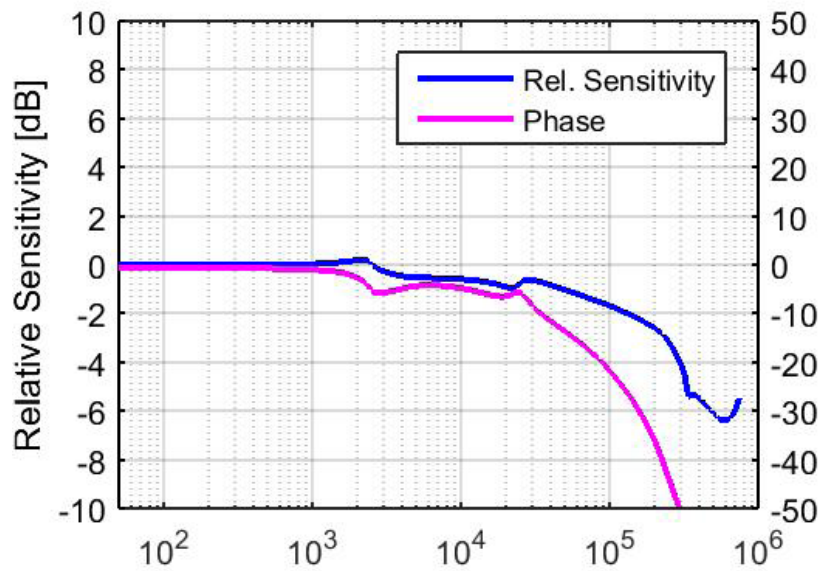

Figure 2: Frequency response

Terms and definitions

Ampere-turns and amperes

The transducer is sensitive to the primary current linkage θ_p (also called ampere-turns).

$$\theta_p = N_p \cdot I_p$$

Where N_p is the number of primary turn (depending on the connection of the primary jumpers).

Caution: As most applications will use the transducer with only one single primary turn ($N_p = 1$), much of this datasheet is written in terms of primary current instead of current linkages. However, the ampere-turns (A) unit is used to emphasis that current linkages are intended and applicable.

Simplified transducer model

The static model of the transducer with current output at temperature T_A is:

$$I_S = S \cdot \theta_p \cdot (1 + \varepsilon)$$

In which (referred to primary):

$$\varepsilon \cdot \theta_p = I_{OE} + I_{OT} + \varepsilon_S \cdot \theta_p + \varepsilon_{ST} \cdot \theta_p + \varepsilon_L(\theta_{Pmax}) \cdot \theta_{Pmax} + I_{OM}$$

- $\theta_p = N_p \cdot I_p$: primary current linkage (A)
- θ_{Pmax} : maximum primary current linkage applied to the transducer
- I_S : secondary current (A)
- S : sensitivity of the transducer
- T_A : ambient operating temperature (°C)
- I_{OE} : electrical offset current (A)
- I_{OM} : magnetic offset current (A)
- I_{OT} : temperature variation of I_{OE} (A)
- ε_S : sensitivity error at 25 °C
- ε_{ST} : thermal drift of S
- $\varepsilon_L(\theta_{Pmax})$: linearity error for θ_{Pmax}

This model is valid for primary ampere-turns θ_p between $-\theta_{Pmax}$ and $+\theta_{Pmax}$ only.

This is the absolute maximum error. As all errors are independent, a more realistic way to calculate the error would be to use the following formula:

$$\varepsilon = \sqrt{\sum_{i=1}^N \varepsilon_i^2}$$

Sensitivity and linearity

To measure sensitivity and linearity, the primary current (DC) is cycled from 0 to I_p , then to $-I_p$ and back to 0 (equally spaced $I_p/10$ steps). The sensitivity S is defined as the slope of the linear regression line for a cycle between $\pm I_{PN}$.

The linearity error ε_L is the maximum positive or negative difference between the measured points and the linear regression line, expressed in % of I_{PN} .

Performance parameters definition

Magnetic offset referred to primary

The magnetic offset current I_{OM} is the consequence of a current on the primary side ("memory effect" of the transducer's ferro-magnetic parts). It is measured using the following primary current cycle. I_{OM} depends on the current value $I_p \geq I_{PN}$.

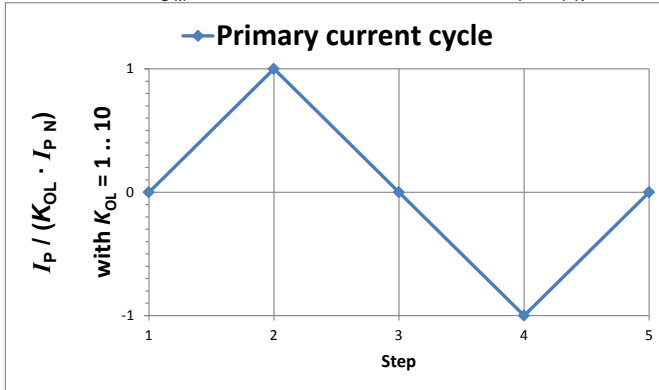

K_{OL} : Overload factor
Figure 3: Current cycle used to measure magnetic and electrical offset (transducer supplied)

$$I_{OM} = \frac{I_{P(3)} - I_{P(5)}}{2}$$

Electrical offset referred to primary

Using the current cycle shown in figure 3, the electrical offset current I_{OE} is the residual output referred to primary when the input current is zero.

$$I_{OE} = \frac{I_{P(3)} + I_{P(5)}}{2}$$

The temperature variation I_{OT} of the electrical offset current I_{OE} is the variation of the electrical offset from 25 °C to the considered temperature.

$$I_{OT}(T) = I_{OE}(T) - I_{OE}(25^{\circ}\text{C})$$

Delay times

The delay time $t_{D,10}$ @ 10 % and the delay time $t_{D,80}$ @ 80 % with respect to the primary are shown in the next figure. Both slightly depend on the primary current di/dt . They are measured at nominal current.

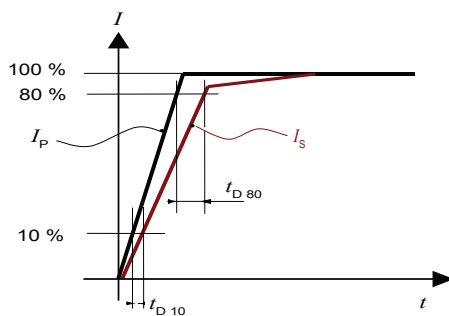

Figure 4: $t_{D,10}$ (delay time @ 10 %) and $t_{D,80}$ (delay time @ 80 %)

Total error referred to primary

The total error ϵ_{tot} is the error at $\pm I_{PN}$, relative to the rated value I_{PN} .

It includes all errors mentioned above

- the electrical offset I_{OE}
- the magnetic offset I_{OM}
- the sensitivity error ϵ_s
- the linearity error ϵ_L (to I_{PN}).

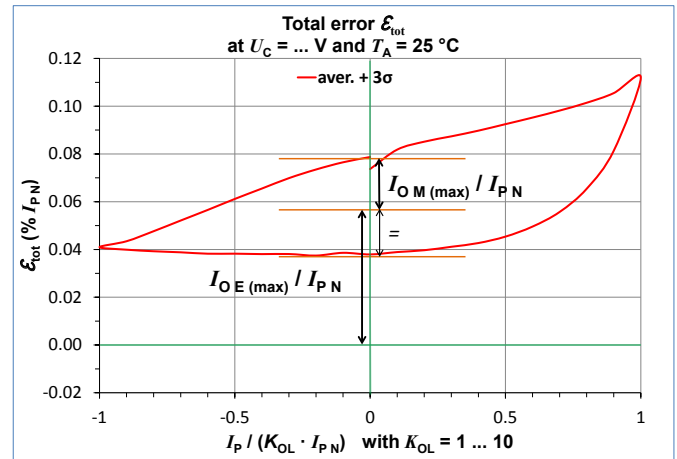

Figure 5: Total error ϵ_{tot}

Definition of typical, minimum and maximum values

Minimum and maximum values for specified limiting and safety conditions have to be understood as such as well as values shown in "typical" graphs.

On the other hand, measured values are part of a statistical distribution that can be specified by an interval with upper and lower limits and a probability for measured values to lie within this interval.

Unless otherwise stated (e.g. "100 % tested"), the LEM definition for such intervals designated with "min" and "max" is that the probability for values of samples to lie in this interval is 99.73 %.

For a normal (Gaussian) distribution, this corresponds to an interval between -3 sigma and +3 sigma. If "typical" values are not obviously mean or average values, those values are defined to delimit intervals with a probability of 68.27 %, corresponding to an interval between -sigma and +sigma for a normal distribution.

Typical, maximal and minimal values are determined during the initial characterization of the product.

Application information

Filtering and decoupling

Supply voltage U_C

The transducer has internal decoupling capacitors, but in the case of a power supply with high impedance, it is highly recommended to provide local decoupling (100 nF or more, located close to the transducer) as it may reduce disturbance on transducer output U_{out} and reference U_{ref} due to high varying primary current. The transducer power supply rejection ratio is low at high frequency.

Output U_{out}

The output U_{out} has a very low output impedance of typically 1 Ohm; it can drive capacitive loads of up to 100 nF directly. Adding series resistance R_f of several tenths of Ohms allows much larger capacitive loads C_f (higher than 1 μ F). Empirical evaluation may be necessary to obtain optimum results. The minimum load resistance on U_{out} is 1 kOhm.

Reference U_{ref}

Likewise output U_{out} , the U_{ref} has a very low output impedance of typically 1 Ohm; it can drive capacitive loads of up to 100 nF directly. Adding series resistance R_f of several tenths of Ohms allows much larger capacitive loads C_f (higher than 1 μ F). Empirical evaluation may be necessary to obtain optimum results. The minimum load resistance on U_{ref} is 10 kOhms.

Overcurrent detection definition

The overcurrent detection function generates an output signal to the OCD pin whenever the primary current exceeds a pre-programmed threshold value. Once the overcurrent event is detected, the CMOS-type OCD signal changes from low logic (< 30 % U_C) to high logic value (> 70 % U_C). In order to avoid undesirable glitches, the OCD signal is digitally filtered and the OCD signal output is held for 1 ms in high logic value after the last overcurrent event detection.

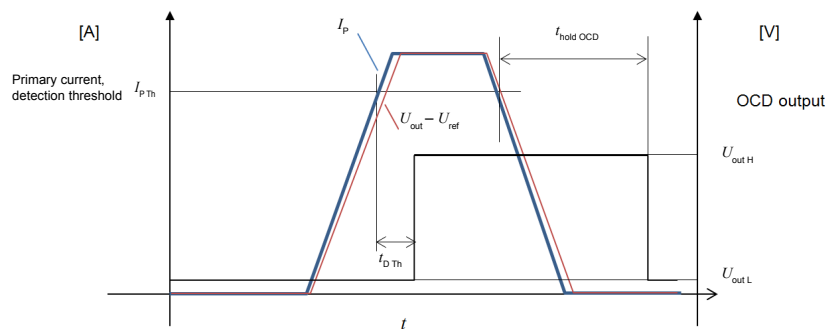

Parameter	Symbol	Unit	Min	Typ	Max	Comment
High-level output voltage	$U_{out\ H}$	V	3.5			With $U_C = +5\text{ V}$ and source current of 3 mA
Low-level output voltage	$U_{out\ L}$	V			1.5	With $U_C = +5\text{ V}$ and sink current of 3 mA

External reference voltage

The REF pin can be used either as a reference voltage output or as a reference voltage input. When used in reference voltage output, the internal reference voltage U_{ref} is used by the transducer as the reference point for bipolar measurements.

The internal reference voltage output accuracy is defined in the electrical parameter data.

When used in reference voltage input, an external reference voltage is connected to the REF pin.

In this case, the maximum allowable reference voltage range is 0.5 V - 2.75 V.

The REF pin must be able to source or sink an input current of 1.5 mA maximum.

If the reference voltage is not used, the REF pin should be left unconnected.

The following graph shows the I_p current versus forced extreme external U_{ref} .

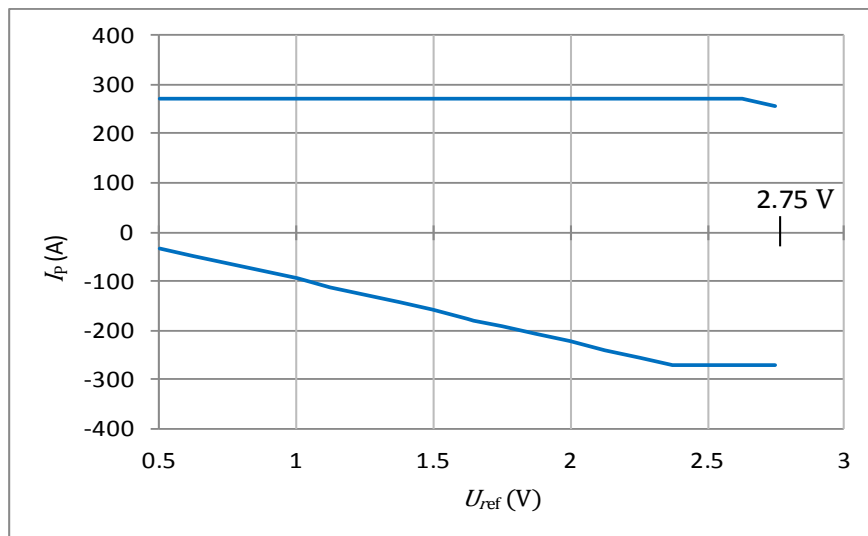

Figure 6: Measuring range versus external U_{ref}

Upper limit: $I_p = 270$ ($U_{ref} = 0.5 \text{ V} \dots 2.75 \text{ V}$)

Lower limit: $I_p = -240 * U_{ref} + 60$ ($U_{ref} = 0.5 \text{ V} \dots 1.37 \text{ V}$)
 $I_p = -270$ ($U_{ref} = 1.37 \text{ V} \dots 2.75 \text{ V}$)

Example with $U_{ref} = 1.25 \text{ V}$:

The transducer has a measuring range from -240 A to +270 A.

Example with $U_{ref} = 0.5 \text{ V}$:

The transducer has a measuring range from -60 A to +270 A.

PCB footprint

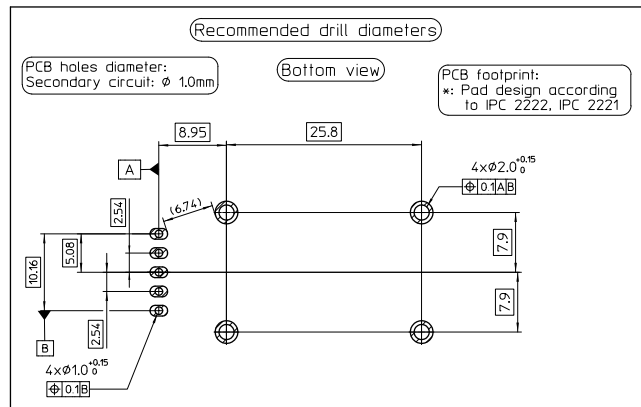

Assembly on PCB

- Recommended PCB hole diameter
 - 1 mm for secondary pin
 - 2 mm for retention pin
- Maximum PCB thickness
 - 2.9 mm
- Wave soldering profile
 - maximum 260 °C for 10 s
 - No clean process only.

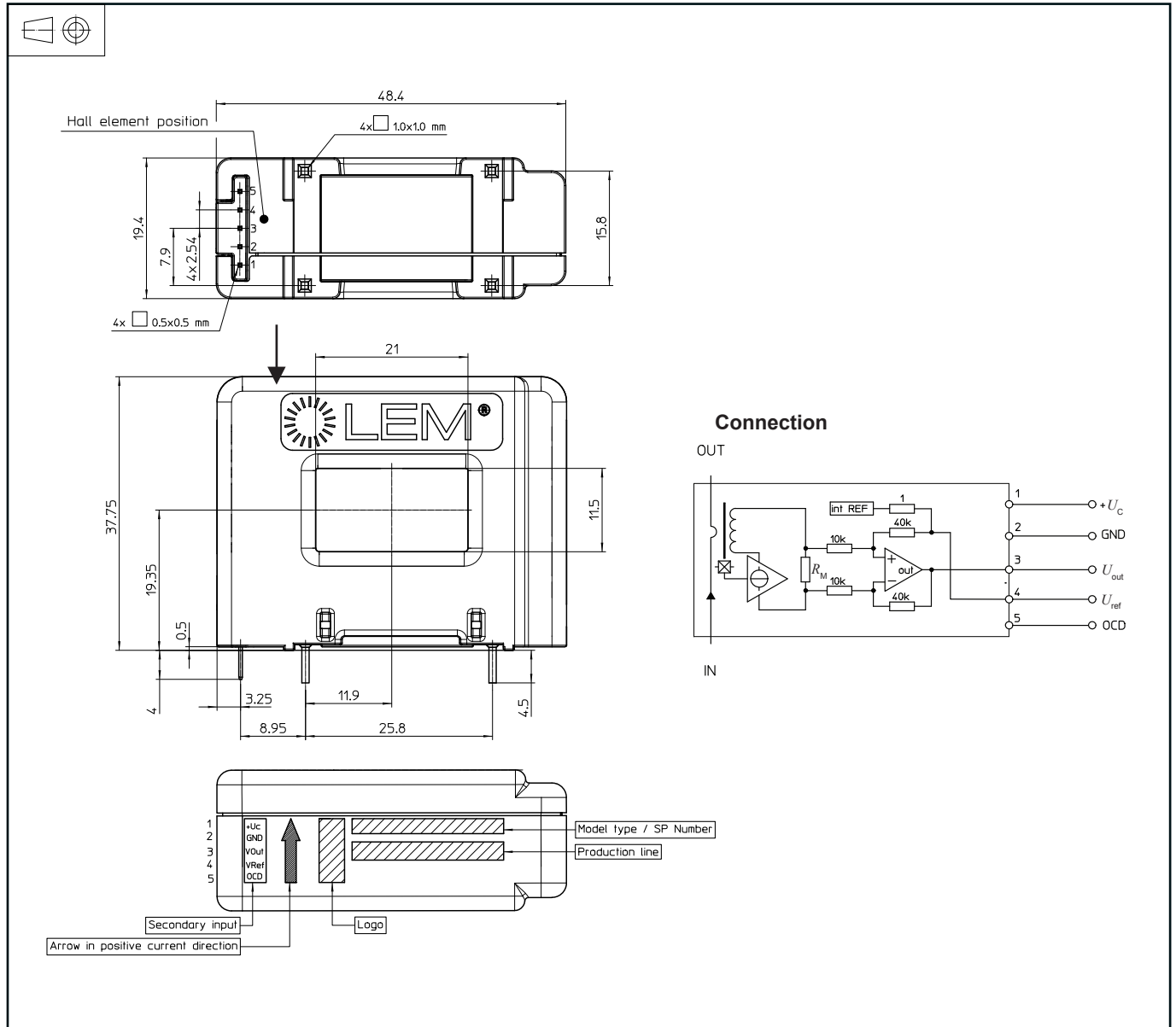
Dimensions (in mm)

Mechanical characteristics

- General tolerance ± 0.6 mm

Remarks

- It is advised to use a primary conductor (busbar) that fills transducer through-hole.
- Be aware of the influence of the external field if nearby transducers are too close (relay, capacitor, choke...).
- Installation of the transducer must be done, unless otherwise specified on the datasheet, according to LEM Transducer Generic Mounting Rules. Please refer to LEM document N°ANE120504 available on our web site: <https://www.lem.com/en/file/3137/download/>.

Packaging information

Standard delivery in cardboard: L × W × H: 300 × 200 × 200 mm

Each cardboard contains 60 parts, placed into 4 Polystyrene-made trays of 15 parts each one.

Both trays and cardboard are ESD-compliant.

The typical weight of the cardboard is 3 Kg.

